

RCCN 日成FD型拨开式线槽 Flexible Wiring Duct

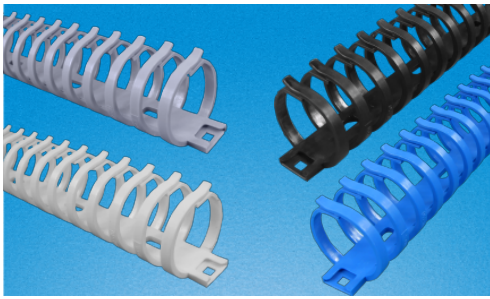

单位/Unit:mm

型号 Item No.				宽 x 高 High X Width W×H	电线容量 以2.0平方计算 Wire capability/2.0sq	标准长度 Standard Length
灰色Gray RAL7030	白色White RAL9016	蓝色Blue RAL5015	黑色Black RAL9005			
标准型						
FD-20G	FD-20W	FD-20E	FD-20B	15×25	5~12pcs	50CM
FD-30G	FD-30W	FD-30E	FD-30B	25×25	10~25pcs	50CM
FD-40G	-	-	-	38×35	15~35pcs	50CM
阻燃型						
FD-20GV0	FD-20WV0	FD-20EV0	FD-20BV0	15×25	5~12pcs	50CM
FD-30GV0	FD-30WV0	FD-30EV0	FD-30BV0	25×25	10~25pcs	50CM
3M承重型						
FD-20G/3M	FD-20W/3M	FD-20E/3M	FD-20B/3M	15×25	5~12pcs	50CM
FD-30G/3M	FD-30W/3M	FD-30E/3M	FD-30B/3M	25×25	10~25pcs	50CM
3M承重阻燃型						
FD-20GV0/3M	FD-20WV0/3M	FD-20EV0/3M	FD-20BV0/3M	15×25	5~12pcs	50CM
FD-30GV0/3M	FD-30WV0/3M	FD-30EV0/3M	FD-30BV0/3M	25×25	10~25pcs	50CM

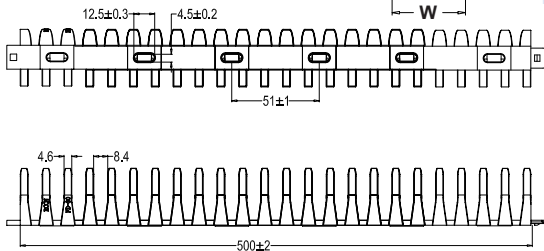
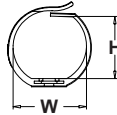

材质:UL尼龙66 94V-2制成,另备94V0阻燃型,附背胶
特点:线槽左右两侧设有连接点可延长

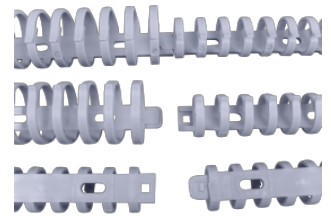

RCCN 日成RD圆形地板配线槽 Round Wiring Duct

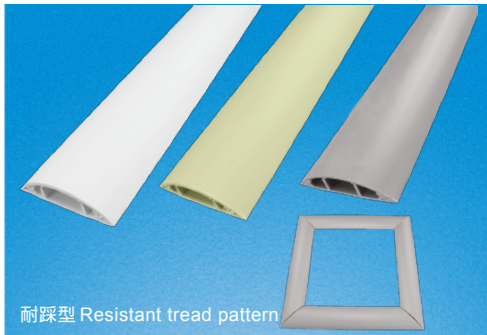

耐踩型 Resistant tread pattern

产品材质:采用硬质PVC料制成,环保无污染,不含铅等有毒物

产品认证:欧洲CE ROHS

防火等级:UL94V-0,低烟微卤,良好自熄灭性,绝缘性特佳

产品构造:由槽底及槽盖组成,槽底配附双面胶

颜色种类:灰色,米黄色,白色,黑色.

工作温度:-40°C持续高温至85°C.

使用方法:将地板擦拭干净后,再将底槽双面胶撕开,黏贴固定於地板上,随后装入电线,盖上槽盖即可

- 产品特性:
1. 圆弧槽盖造型设计,具美观及抗重压之功能,不绊倒人及更易于搬运车通过.
 2. 配线槽85°C内不易断裂,变形,变色,装配省时便利
 3. 组合容易、拆卸简单、易于配线。
 4. 密封式无出线孔,能防尘、防鼠,适用于工程施工及建厂之导线或配明线用。

长度说明:默认出货为1M,如需2M需订购时说明.定制其它颜色有起订要求.

*Backed with high quality double sided tape for permanent fixture.

*Good for loor wiring to facilitate trolley pass and to avoid tripping, especially in public places, like shopping malls, hospitals, and stations.

*Material: PVC

*Length: 2 M

*Color: All colors are available

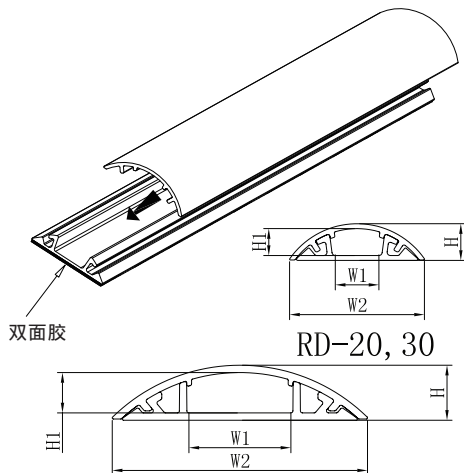

RD-40, 50, 60, 70, 80, 90, 120

适用于办公室,学校,超市,工厂生产流水线,建筑装潢等的地面墙面走线用.汽车压不坏,高跟鞋踩不烂.

Used in wiring of schools, office, factory and so on

*号常规备货品

*Means available in stock

单位/Unit:mm

型号 Item No.				外宽 Outside width W2	内宽 Inside width W1	高度 Height H	内高 Inside height H2	长度 Length
灰色/Gray	米黄色/Beige	白色/White	黑色/Black					
RD-20	RD-20Y	RD-20W	RD-20B	20	8	6	4	1米或2米 1M or 2M
RD-30	RD-30Y	RD-30W	RD-30B	30	11	8	6.5	
RD-40	RD-40Y	RD-40W	RD-40B	40	12	11	8	Including turning and lids 含槽底槽盖
* RD-50	* RD-50Y	* RD-50W	* RD-50B	50	20	12.5	8.8	
* RD-70	* RD-70Y	* RD-70W	* RD-70B	70	20	16.5	12.7	
* RD-80	* RD-80Y	* RD-80W	* RD-80B	80	20	16.5	12.7	
RD-90	RD-90Y	RD-90W	RD-90B	90	25	19	15	
RD-120	RD-120Y	RD-120W	RD-120B	120	30	25	21	

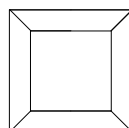

方形
Square

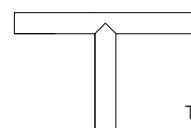

T形
T-shaped